

Techn. Daten Garage A

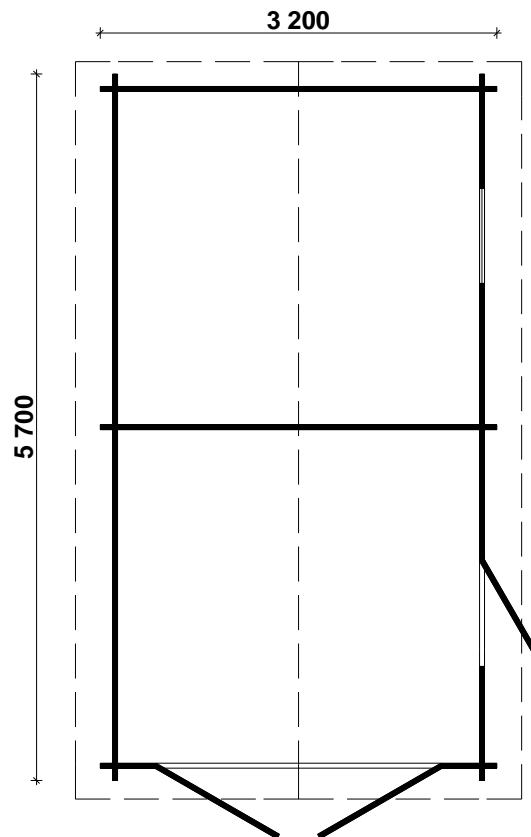

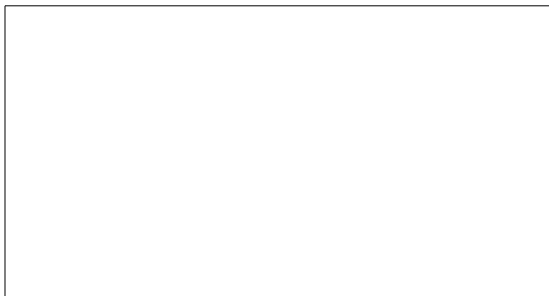

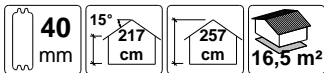









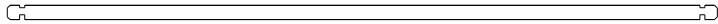

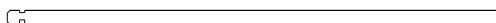

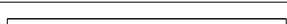
Bohlenaußenmaß (B x T): 320 x 570 cm

Wandaußenmaß: 300 x 550 cm · Bohlenstärke: 40 mm

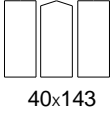
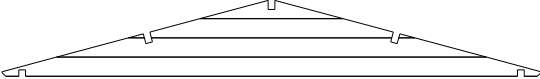

Achtung : Alle angegebenen Maße sind ca. - Maße !

Garage A 40 - 320 x 570 cm

Nr	Beschreibung	Profil mm	Länge mm	Stück
1			410	2
2			3200	1
3			3200	20
4			5700	17
5			5700	2
6			3930	8
7			920	26
8			410	34
9			2240	9
10	Abgeschrägte Vordachbohle 	 40x120	5950	2(1+1)
11	Dachbalken 	 40x143	5950	3(2+1)
12	Giebel 	 114	3200	3
13	Einzeltür ca. 840 x 1890mm			1
14	Doppeltür ca. 2370 x 1955mm			1
15	Einzelfenster ca. 765 x 990mm			1
16	Dachpappe			Rolle
17	Dachbretter	Vers. 1 >  18x88	2000	136+2
		Vers. 2 >  18x110	2000	110+2
18	Giebelblende 	18x110	2034	4
19	Giebelabschlussbrett	16x35	2034	4
20	Traufenbrett	18x90	2975	4
21	Traufenleiste	28x28	2975	4
22	Raute 			2
23	Schrauben 4,0 x 40			1 Beutel
24	Nägeln 2,5 x 50			1 Beutel
25	Dachpappnägel 3,0 x 15			1 Beutel
26	Sturmleisten 		2150	4
27	Schloßschrauben M 8 x 70, Mutter, Scheibe			12
28	Fundament	28x55	3000/2695	2/4
29	Schlaghölzer		300-400	3

Garage A 40 - 320 x 570 cm

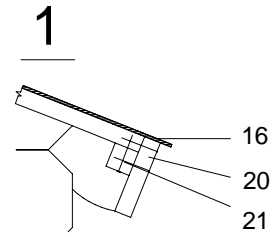
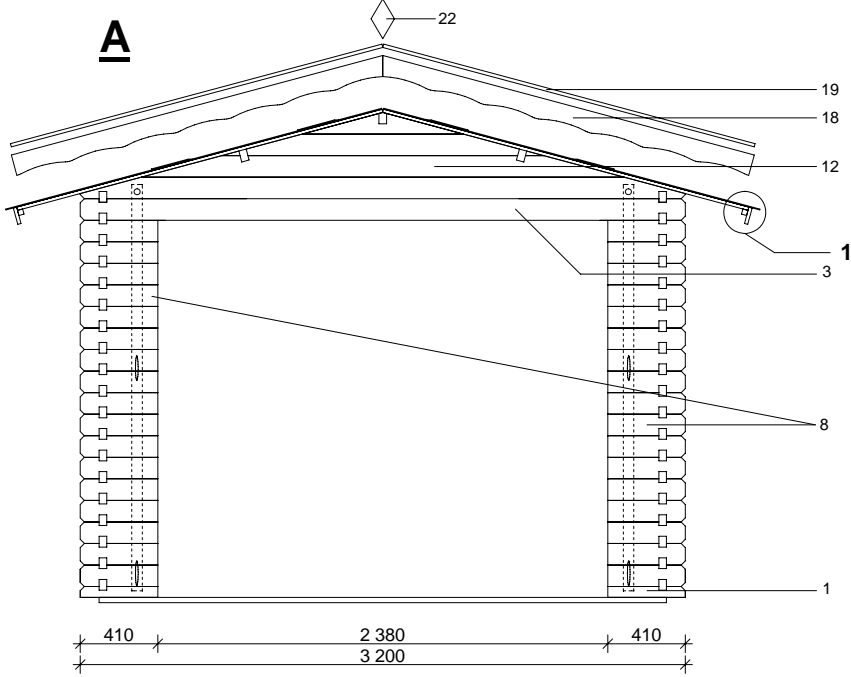

A-A

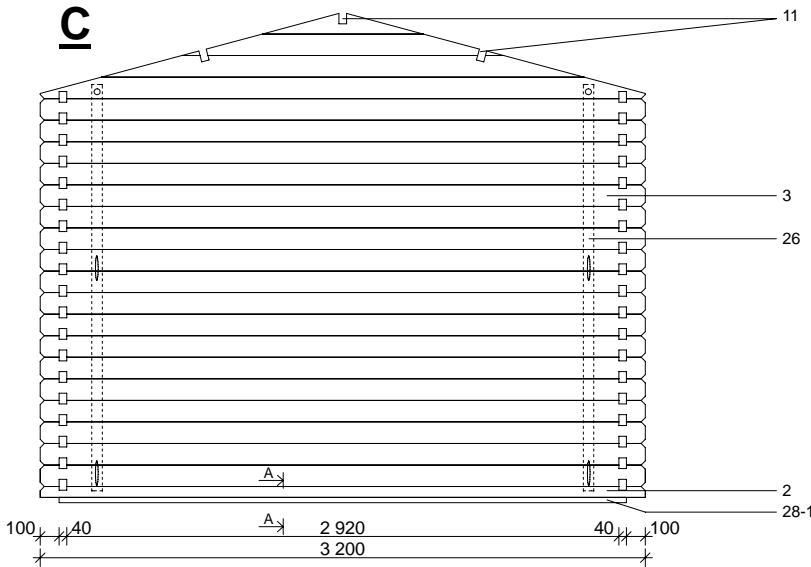

B-B

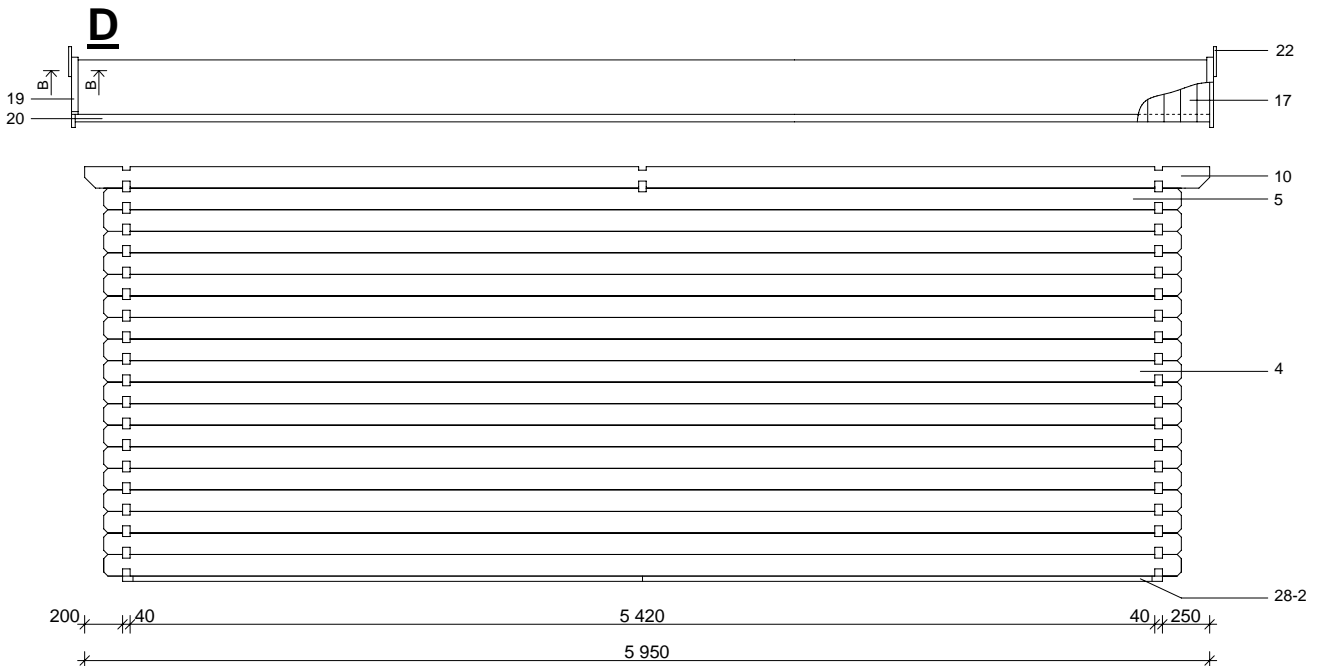
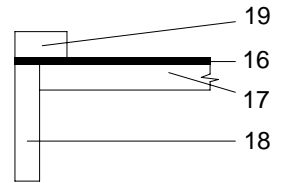

Garage A 40 - 320 x 570 cm

E

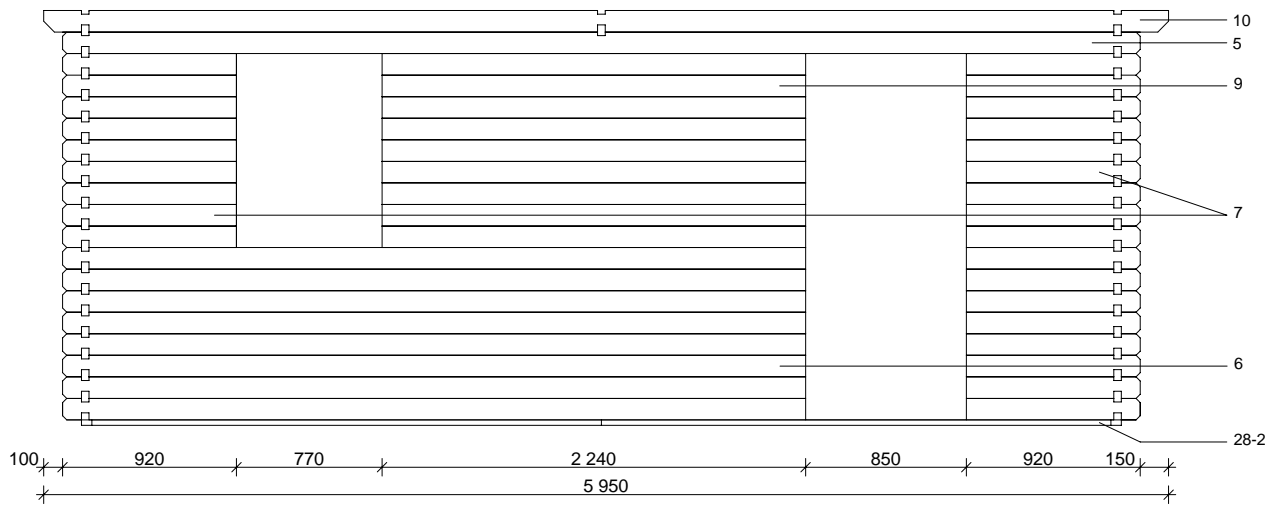

B

