

# Techn. Data: Alabama 28

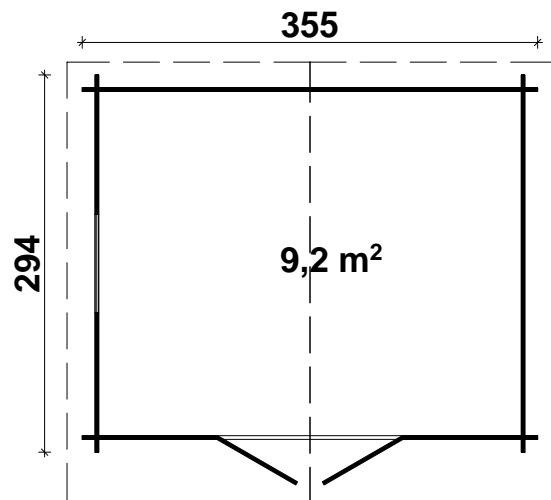









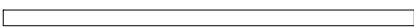

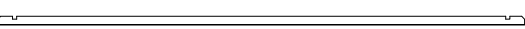

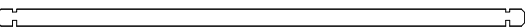

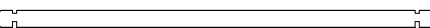

Log length (W x D): 355 x 294 cm

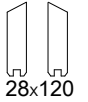
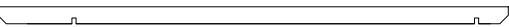
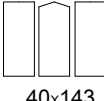
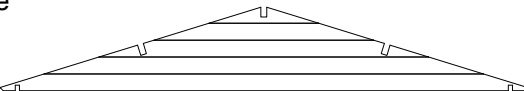
Wall size(outside): 335 x 274 cm · Log thickness: 28 mm

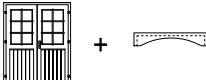
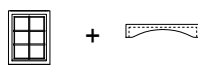

Note: All dimensions are approximate !

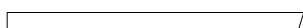
# Specification - Alabama 28 mm

Nr	Description	Profile mm	Lenght mm	Amount
1	Foundation 	□ 45x70	3343	2
2	Foundation 		2643	10
3			3553	2
4			3553	16
5			2943	21
6			1087	18
7			1057	32
8			3143	2
9				--
10			--	--
11			--	--
12			3443	2
13	Purlin 		3443	3(2+1)
14	Gable 		3553	2
15	Door ca. 1425 x 1775 mm			1/2
16	Window ca. 765 x 990 mm			1/1
17	Roofing felt			--
18	Roof boards	Vers. 1 >		--
		Vers. 2 >		1960
19	Floor boards	Vers. 1 >		--
		Vers. 2 >		3295
20	Facia boards 	18x115	2000	4
21	Roofing felt fillet	16x35	2000	4
22	Eavesboard	18x90	3443	2
23	Eavesboard	25x38	3443	2
24	Rhomb 			2
25	Baseboard 			ca. 12 m
26	Screws 4,0 x 40			1 packet
27	Nails 2,2 x 50			1 packet
28	Storm braces		1900	4
29	M 8 x 60, Nut , Washer			12
30	Roofing felt nails 2,8 x 15			-
31	Hitblock		300-400	

# Alabama 28

## Foundation

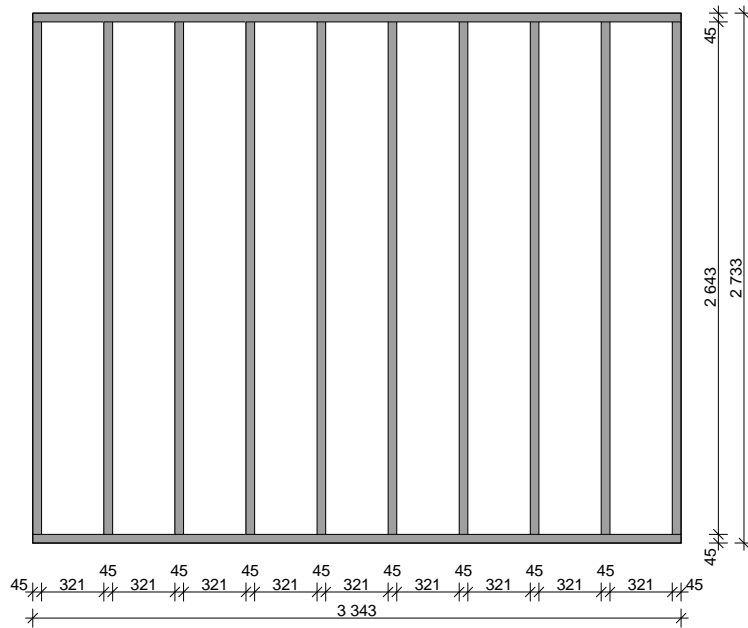

## Groundplan

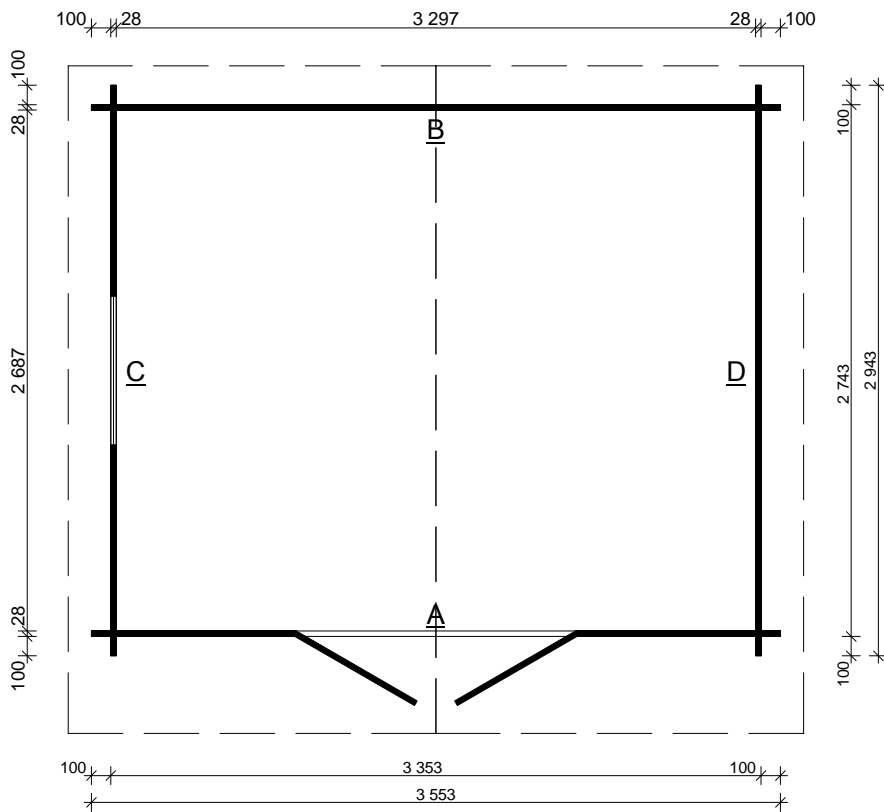

# Alabama 28

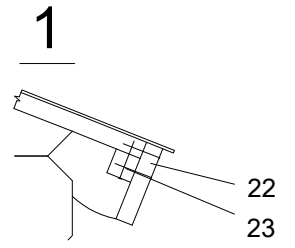
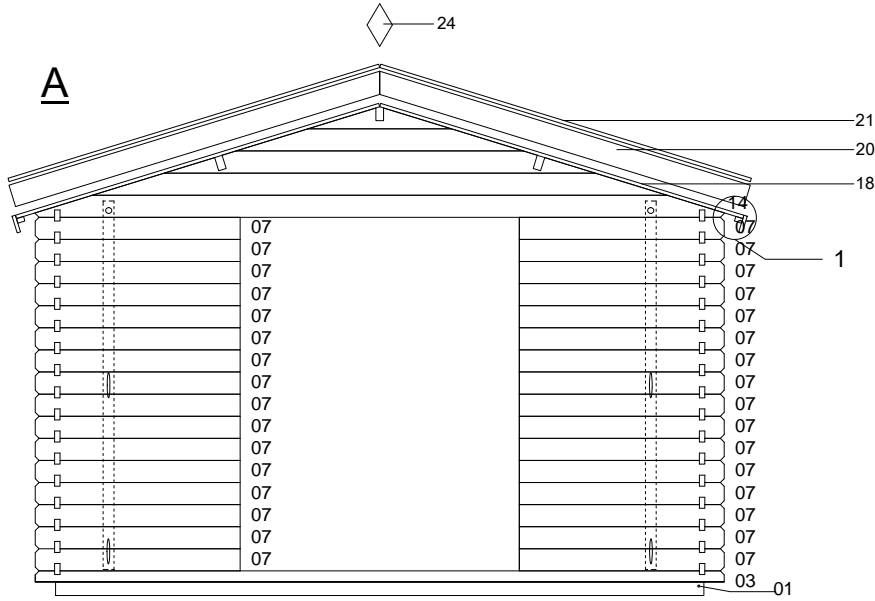

## A-A

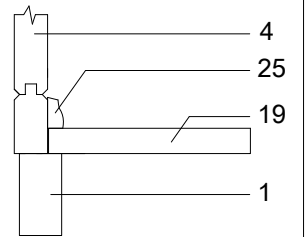

1056 1440 1056 3553

## B

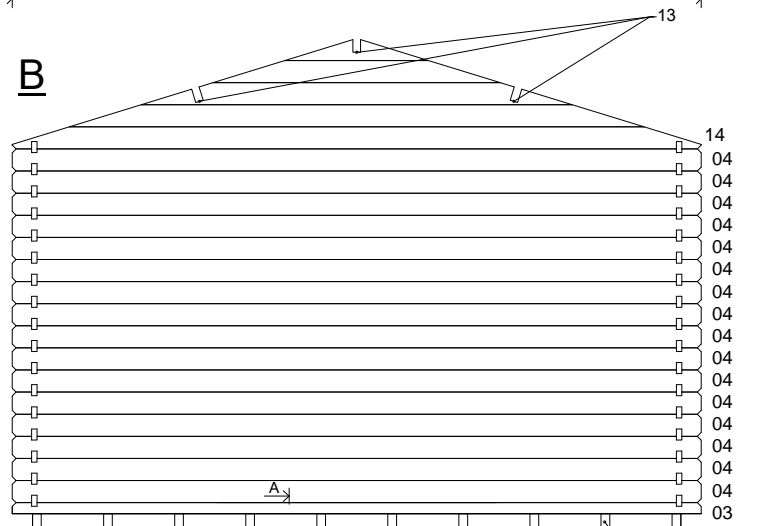

## B-B

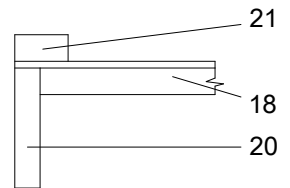

100 28 3297 28 100 3553 02

## C

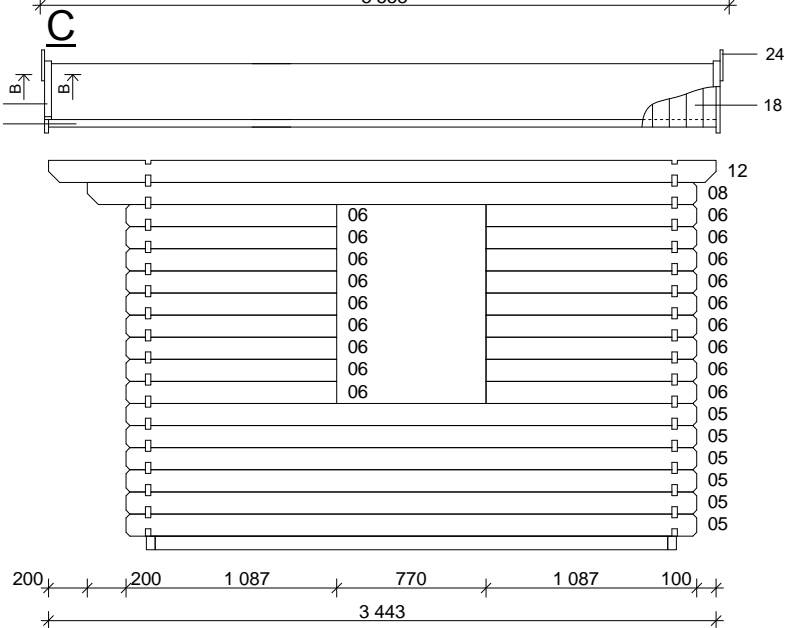

200 200 1087 770 1087 100 3443

# Alabama 28

